

NATIONAL ELIGIBILITY CUM ENTRANCE TEST

NEET(UG), 2015 (CODE-C)

Answers & Solutions

Physics

1. A photoelectric surface is illuminated successively by monochromatic light of wavelength λ and $\frac{\lambda}{2}$. If the maximum kinetic energy of the emitted photoelectrons in the second case is 3 times that in the first case, the work function of the surface of the material is:

(h = Planck's constant, c = speed of light)

- (1) $\frac{2hc}{\lambda}$
- (2) $\frac{hc}{3\lambda}$
- (3) $\frac{hc}{2\lambda}$
- (4) $\frac{hc}{\lambda}$

Solution: (3)

$$k_1 = \frac{hc}{\lambda} - \psi$$

$$k_2 = 3k_1 = \frac{2hc}{\lambda} - \psi = \frac{3hc}{\lambda} - 3\psi$$

$$\text{So } 2\psi = \frac{hc}{\lambda}$$

$$\text{So } \psi = \frac{hc}{2\lambda}$$

2. The input signal given to a CE amplifier having a voltage gain of 150 is $V_i = 2 \cos\left(15t + \frac{\pi}{3}\right)$. The corresponding output signal will be:

- (1) $2 \cos\left(15t + \frac{5\pi}{6}\right)$
- (2) $300 \cos\left(15t + \frac{4\pi}{3}\right)$
- (3) $300 \cos\left(15t + \frac{\pi}{3}\right)$
- (4) $75 \cos\left(15t + \frac{2\pi}{3}\right)$

Solution: (2)

CE amplifier causes phase difference of $\pi (= 180^\circ)$ so $V_{\text{out}} = 300 \cos\left(15t + \frac{\pi}{3} + \pi\right)$

3. A series R-C circuit is connected to an alternating voltage source. Consider two situations:
- i. When capacitor is air filled.
 - ii. When capacitor is mica filled.

Current through resistor is i and voltage across capacitor is V then:

- (1) $i_a > i_b$
- (2) $V_a = V_b$
- (3) $V_a < V_b$

(4) $V_a > V_b$

Solution: (4)

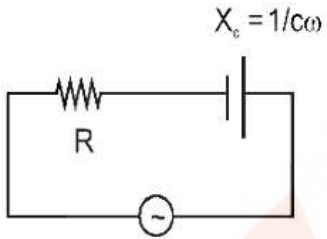

$$i = \frac{v}{\sqrt{R^2 + \left(\frac{1}{c\omega}\right)^2}}$$

$$V_C = \frac{v}{\sqrt{R^2 + \left(\frac{1}{c\omega}\right)^2}} \times \left(\frac{1}{c\omega}\right)$$

$$V_C = \frac{V}{\sqrt{(Rc\omega)^2 + 1}}$$

If we fill a di-electric material

$$C \uparrow \Rightarrow V_C \downarrow$$

Ans is (4)

4. Point masses m_1 and m_2 are placed at the opposite ends of rigid rod of length L , and negligible mass. The rod is to be set rotating about an axis perpendicular to it. The position of point P on this rod through which the axis should pass so that the work required to set the rod rotating with angular velocity ω_0 is minimum, is given by:

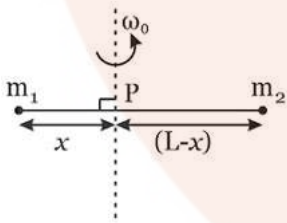

(1) $x = \frac{m_2}{m_1} L$

(2) $x = \frac{m_2 L}{m_1 + m_2}$

(3) $x = \frac{m_1 L}{m_1 + m_2}$

(4) $x = \frac{m_1}{m_2} L$

Solution: (2)

$$K.E. = \frac{1}{2} I \omega^2$$

I is min. about the centre of mass

$$\text{So, } (m_1)(x) = (m_2)(L - x)$$

$$x = \frac{m_2 L}{m_1 + m_2}$$

5. A parallel plate air capacitor has capacity 'C', distance of separation between plates is 'd' and potential difference 'V' is applied between the plates. Force of attraction between the plates of the parallel plate air capacitor is:

- (1) $\frac{CV^2}{d}$
- (2) $\frac{C^2V^2}{2d^2}$
- (3) $\frac{C^2V^2}{2d}$
- (4) $\frac{CV^2}{2d}$

Solution: (4)

Attraction between the plates

$$F = \frac{q^2}{2A\epsilon_0} \text{ where } q = CV \text{ and } C = \frac{\epsilon_0 A}{d}$$

$$F = \frac{C^2V^2}{2Cd} = \frac{CV^2}{2d}$$

6. An ideal gas is compressed to half its initial volume by means of several processes. Which of the process results in the maximum work done on the gas?

- (1) Isochoric
- (2) Isothermal
- (3) Adiabatic
- (4) Isobaric

Solution: (3)

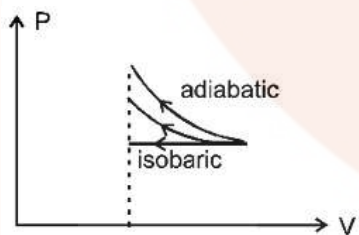

Since area under the curve is max for adiabatic process so work done on the gas will be max for adiabatic process.

7. A beam of light consisting of red, green and blue colours is incident on a right angled prism. The refractive index of the material of the prism for the above red, green and blue wavelengths are 1.39, 1.44 and 1.47 respectively.

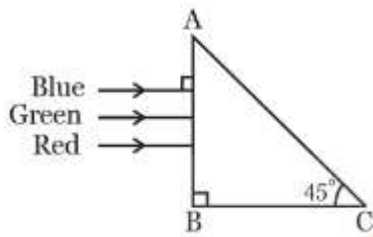

The prism will:

- (1) Not separate the three colours at all
- (2) Separate the red colour part from the green and blue colours
- (3) Separate the blue colour part from the red and green colours
- (4) Separate all the three colours from one another

Solution: (2)

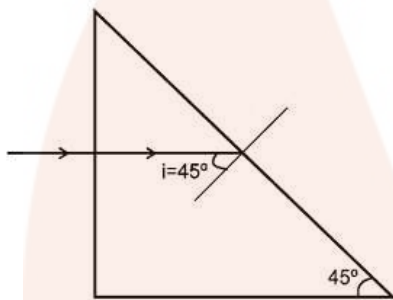

For TIR $i > i_c$ so $\sin i > \sin i_c$

$$\sin 45^\circ > \frac{1}{\mu} \Rightarrow \mu\sqrt{2} \Rightarrow \mu = 1.414$$

Since μ of green and violet are greater than 1.414 so they will total internal refracted. But red colour will be refracted.

So Ans. is (2)

8. Two vessels separately contain two ideal gases A and B at the same temperature, the pressure of A being twice that of B. Under such conditions, the density of A is found to be 1.5 times the density of B. The ratio of molecular weight of A and B is:

- (1) 2
- (2) $\frac{1}{2}$
- (3) $\frac{2}{3}$
- (4) $\frac{3}{4}$

Solution: (4)

$$P_A = \frac{\rho_A M_A}{RT}, P_B = \frac{\rho_B M_B}{RT} = \frac{3}{2} \Rightarrow \frac{P_A}{P_B} = \frac{\rho_A}{\rho_B} \frac{M_A}{M_B} = 2 \frac{M_A}{M_B} = \frac{3}{2}$$

$$\text{So, } \frac{M_A}{M_B} = \frac{3}{4}$$

9. A remote-sensing satellite of earth revolves in a circular orbit at a height of 0.25×10^6 m above the surface of earth. If earth's radius is 6.38×10^6 m and $g = 9.8 \text{ ms}^{-2}$, then the orbital speed of the satellite is:

- (1) 9.13 km s^{-1}
- (2) 6.67 km s^{-1}
- (3) 7.76 km s^{-1}
- (4) 8.56 km s^{-1}

Solution: (3)

$$V_0 = \sqrt{\frac{GM}{r}} = \sqrt{\frac{GM}{R^2} \cdot \frac{R^2}{r}}$$
$$= \sqrt{\frac{9.8 \times 6.38 \times 6.38}{6.63 \times 10^6}} = \sqrt{60 \times 10^6} \text{ m/sec}$$
$$= 7.76 \text{ km/sec}$$

10. The energy of the em waves is of the order of 15 keV. To which part of the spectrum does it belong?

- (1) Ultraviolet rays
- (2) γ -rays
- (3) X-rays
- (4) Ultraviolet rays

Solution: (3)

Wavelength of the ray

$$\lambda = \frac{hc}{E}$$
$$= 0.826 \text{ \AA}$$

Since $\lambda < 100 \text{ \AA}$

So it is X-ray

11. A proton and an alpha particle both enter a region of uniform magnetic field B, moving at right angles to the field B. if the radius of circular orbits for both the particles is equal and the kinetic energy acquired by proton is 1 MeV, the energy acquired by the alpha particle will be:

- (1) 1.5 MeV
- (2) 1 MeV
- (3) 4 MeV
- (4) **0.5 MeV**

Solution: (2)

$$R = \frac{mV}{qB} = \frac{\sqrt{2m(kE)}}{qB}$$

Since R is same so $KE \propto \frac{q^2}{m}$

So KE of α particle will be $\frac{(2)^2}{4} = \text{same} = 1 \text{ MeV}$

Ans. is (2)

12. If vectors $\vec{A} = \cos \omega t \hat{i} + \sin \omega t \hat{j}$ and $\vec{B} = \cos \frac{\omega t}{2} \hat{i} + \sin \frac{\omega t}{2} \hat{j}$ are functions of times, then the value of t at which they are orthogonal to each other is:

- (1) $t = \frac{\pi}{\omega}$
- (2) $t = 0$
- (3) $t = \frac{\pi}{4\omega}$
- (4) $t = \frac{\pi}{2\omega}$

Solution: (1)

$$\vec{A} = \cos \omega t \hat{i} + \sin \omega t \hat{j}$$

$$\vec{B} = \cos \frac{\omega t}{2} \hat{i} + \sin \frac{\omega t}{2} \hat{j}$$

$$\text{for } \vec{A} \cdot \vec{B} = 0$$

$$\vec{A} \cdot \vec{B} = 0 = \cos \omega t \cdot \cos \frac{\omega t}{2} + \sin \omega t \cdot \sin \frac{\omega t}{2}$$

$$= \cos \left(\omega t - \frac{\omega t}{2} \right) = \cos \left(\frac{\omega t}{2} \right)$$

$$\text{So } \frac{\omega t}{2} = \frac{\pi}{2}$$

$$\Rightarrow t = \frac{\pi}{\omega}$$

13. A rectangular coil of length 0.12 m and width 0.1 m having 50 turns of wire is suspended vertically in a uniform magnetic field of strength 0.2 Weber/m². The coil carries a current of 2A. if the plane of the coil is inclined at an angle of 30° with the direction of the field, the torque required to keep coil in stable equilibrium will be:

- (1) 0.24 Nm
- (2) 0.12 Nm
- (3) 0.15 Nm
- (4) 0.20 Nm

Solution: (4)

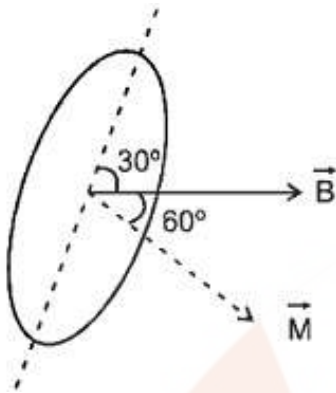

$$\vec{\tau} = \vec{M} \times \vec{B} = MB \sin 60^\circ$$

$$= Ni AB \sin 60^\circ$$

$$50 \times 2 \times 0.12 \times 0.1 \times 0.2 \times \frac{\sqrt{3}}{2}$$

$$= 12\sqrt{3} \times 10^{-2} \text{ Nm} = 0.20748 \text{ Nm}$$

14. An automobile moves on a road with a speed of 54 km h^{-1} . The radius of its wheels is 0.45 m and the moment of inertia of the wheel about its axis of rotation is 3 kg m^2 . If the vehicle is brought to rest in 15 s , the magnitude of average torque transmitted by its brakes to the wheel is:

- (1) $10.86 \text{ kg m}^2 \text{ s}^{-2}$
- (2) $2.86 \text{ kg m}^2 \text{ s}^{-2}$
- (3) $6.66 \text{ kg m}^2 \text{ s}^{-2}$
- (4) $8.58 \text{ kg m}^2 \text{ s}^{-2}$

Solution: (3)

$$\omega_i = \frac{15}{0.45} = \frac{100}{3} \quad \omega_f = 0$$

$$\omega_f = \omega_i + \alpha t$$

$$0 = \frac{100}{3} + (-\alpha)(15)$$

$$\alpha = \frac{100}{45}$$

$$\tau = (I)(\alpha) = 3 \times \frac{100}{45} = 6.66 \text{ N.M}$$

15. Two metal wires of identical dimensions are connected in series. If v_1 and v_2 are the conductivities of the metal wires respectively, the effective conductivity if the combination is:

- (1) $\frac{\sigma_1 + \sigma_2}{\sigma_1 \sigma_2}$

- (2) $\frac{\sigma_1 \sigma_2}{\sigma_1 + \sigma_2}$
 (3) $\frac{2\sigma_1 \sigma_2}{\sigma_1 + \sigma_2}$
 (4) $\frac{\sigma_1 + \sigma_2}{2\sigma_1 \sigma_2}$

Solution: (3)

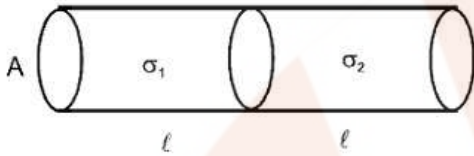

$$R_{ec} = \frac{\ell}{\sigma_1 A} + \frac{\ell}{\sigma_2 A} = \frac{\ell_{eq}}{\sigma_{eq} A_{eq}}$$

$$\frac{2\ell}{\sigma_{eq} A} = \frac{\ell}{A} \left(\frac{\sigma_1 + \sigma_2}{\sigma_1 \sigma_2} \right)$$

$$\sigma_{eq} = \frac{2\sigma_1 \sigma_2}{\sigma_1 + \sigma_2}$$

Ans. (3)

16. If potential (in volts) in a region is expressed as $V(x, y, z) = 6xy - y + 2yz$, the electric field (in N/C) at point $(1, 1, 0)$ is:

- (1) $-(2\hat{i} + 3\hat{j} + \hat{k})$
 (2) $-(6\hat{i} + 9\hat{j} + \hat{k})$
 (3) $-(3\hat{i} + 5\hat{j} + 3\hat{k})$
 (4) $-(6\hat{i} + 5\hat{j} + 2\hat{k})$

Solution: (4)

$$V = 6xy - y + 24z$$

$$\vec{E} = \left(\frac{\partial V}{\partial x} \hat{i} + \frac{\partial V}{\partial y} \hat{j} + \frac{\partial V}{\partial z} \hat{k} \right)$$

$$\vec{E} = [(6y)\hat{i} + (6x - 1 + 2z)\hat{j} + (2y)\hat{k}]$$

$$\vec{E} = -(6\hat{i} + 5\hat{j} + 2\hat{k})$$

$(1, 1, 0)$

17. Two particles A and B move with constant velocities \vec{v}_1 and \vec{v}_2 . At the initial moment their position vectors \vec{r}_1 and \vec{r}_2 respectively. The condition for particles A and B for their collision is:

- (1) $\vec{r}_1 \times \vec{v}_1 = \vec{r}_2 \times \vec{v}_2$
 (2) $\vec{r}_1 - \vec{r}_2 = \vec{v}_1 - \vec{v}_2$
 (3) $\frac{\vec{r}_1 - \vec{r}_2}{|\vec{r}_1 - \vec{r}_2|} = \frac{\vec{v}_2 - \vec{v}_1}{|\vec{v}_2 - \vec{v}_1|}$

$$(4) \vec{r}_1 \cdot \vec{v}_1 = \vec{r}_2 \cdot \vec{v}_2$$

Solution: (3)

For two particles to collide, the direction of the relative velocity of one with respect to other should be directed towards the relative position of the other particle

$$\text{i.e. } \frac{\vec{r}_1 - \vec{r}_2}{|\vec{r}_1 - \vec{r}_2|} \rightarrow \text{direction of relative position of 1 w.r.t..2.}$$

$$\& \frac{\vec{v}_2 - \vec{v}_1}{|\vec{v}_2 - \vec{v}_1|} \rightarrow \text{direction of velocity of 2 w.r.t.1}$$

So for collision of A & B

$$\frac{\vec{r}_1 - \vec{r}_2}{|\vec{r}_1 - \vec{r}_2|} = \frac{\vec{v}_2 - \vec{v}_1}{|\vec{v}_2 - \vec{v}_1|}$$

18. 4.0 g of a gas occupies 22.4 liters at NTP. The specific heat capacity of the gas at constant volume is $5.0 \text{ JK}^{-1} \text{ mol}^{-1}$. If the speed of sound in this gas at NTP is 952 ms^{-1} , then the heat capacity at constant pressure is (Take gas constant $R = 8.3 \text{ JK}^{-1} \text{ mol}^{-1}$)

- (1) $7.0 \text{ JK}^{-1} \text{ mol}^{-1}$
- (2) $8.5 \text{ JK}^{-1} \text{ mol}^{-1}$
- (3) $8.0 \text{ JK}^{-1} \text{ mol}^{-1}$
- (4) $7.5 \text{ JK}^{-1} \text{ mol}^{-1}$

Solution: (3)

No. of mole of gas = 1 so molar mass = 4g/mole

$$V = \sqrt{\frac{\gamma RT}{m}} \Rightarrow 952 \times 952 = \frac{\gamma \times 3.3 \times 273}{4 \times 10^{-3}} \Rightarrow \gamma = 1.6 = \frac{16}{10} = \frac{8}{5}$$

19. A force $\vec{F} = \alpha \hat{i} + 3\hat{j} + 6\hat{k}$ is acting at a point $\vec{r} = 2\hat{i} - 6\hat{j} - 12\hat{k}$. The value of α for which angular momentum about origin is conserved is:

- (1) Zero
- (2) 1
- (3) -1
- (4) 2

Solution: (3)

If $\vec{L} = \text{constant}$ then $\vec{\tau} = 0$

So $\vec{r} \times \vec{F} = 0 \Rightarrow \vec{F}$ should be parallel to \vec{r} so coefficient should be in same ratio. So $\frac{\alpha}{2} = \frac{3}{-6} = \frac{6}{-12}$

So $\alpha = -1$

Ans (3)

20. At the first minimum adjacent to the central maximum of a single-slit diffraction pattern, the phase difference between the Huygen's wavelet from the edge of the slit and the wavelet from the midpoint of the slit is:

- (1) π radian
- (2) $\frac{\pi}{8}$ radian
- (3) $\frac{\pi}{4}$ radian
- (4) $\frac{\pi}{2}$ radian

Solution: (1)

For first minima

$$AP - BP = \lambda$$

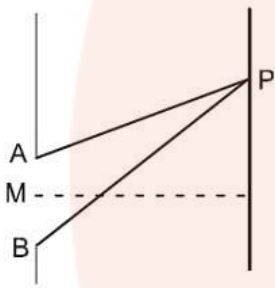

$$AP - MP = \frac{\lambda}{2}$$

$$\text{So phase difference} = \frac{2\pi}{\lambda} \times \frac{\lambda}{2} = \pi$$

21. The heart of a man pumps 5 litres of blood through the arteries per minute at a pressure of 150 mm of mercury. If the density of mercury be $13.6 \times 10^3 \text{ kg/m}^3$ and $g = 10 \text{ m/s}^2$ then the power of heart in watt is:

- (1) 3.0
- (2) 1.50
- (3) 1.70
- (4) **2.35**

Solution: (3)

$$\text{Power} = \vec{F} \cdot \vec{V} = P A \vec{V} = \rho g h A V$$

$$= 13.6 \times 10^3 \times 10 \times 150 \times 10^{-3} \times 0.5 \times 10^{-3} / 60 \text{ watt}$$

$$= \frac{102}{60} \text{ watt} = 1.70 \text{ watt.}$$

22. A ball is thrown vertically downwards from a height of 20 m with an initial velocity v_0 . It collides with the ground, loses 50 percent of its energy in collision and rebounds to the same height. The initial velocity v_0 is: (Take $g = 10 \text{ ms}^{-2}$)

- (1) 28 ms^{-1}
- (2) 10 ms^{-1}
- (3) 14 ms^{-1}
- (4) 20 ms^{-1}

Solution: (4)

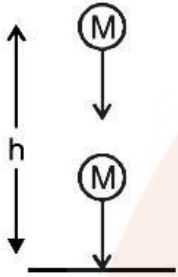

$$\frac{KE_f}{KE_i} = \frac{1}{2}$$

$$\frac{V_f}{V_i} = \frac{1}{\sqrt{2}}$$

$$\frac{\sqrt{2gh}}{\sqrt{V_0^2 + 2gh}} = \frac{1}{\sqrt{2}}$$

$$V_0 = 20 \text{ m/sec}$$

23. The cylindrical tube of a spray pump has radius R , one end of which has n fine holes, each of radius r . If the speed of the liquid in the tube is V , the speed of the ejection of the liquid through the holes is :

- (1) $\frac{VR^2}{n^3r^2}$
- (2) $\frac{V^2R}{nr}$
- (3) $\frac{VR^2}{n^2r^2}$
- (4) $\frac{VR^2}{nr^2}$

Solution: (4)

Volume inflow rate = volume outflow rate

$$\pi R^2 V = n \pi r^2 v \Rightarrow v = \frac{\pi R^2 V}{n \pi r^2} = \frac{VR^2}{nr^2}$$

24. A string is stretched between fixed points separated by 75.0 cm. It is observed to have resonant frequencies of 420 Hz and 315 Hz. There are no other resonant frequency for this string is:

- (1) 10.5 Hz
- (2) 105 Hz
- (3) 155 Hz
- (4) 205 Hz

Solution: (2)

Two consecutive resonant frequencies for a string fixed at both ends will be

$$\frac{nv}{2\ell} \text{ and } \frac{(n+1)v}{2\ell}$$

$$\Rightarrow \frac{(n+1)v}{2\ell} - \frac{nv}{2\ell} = 420 - 315$$

$$\frac{v}{2\ell} = 105 \text{ Hz}$$

Which is the minimum resonant frequency.

25. If dimensions of critical velocity v_c of a liquid flowing through a tube are expressed as $[\eta^x \rho^y r^z]$, where η , ρ and r are the coefficient of viscosity of liquid, density of liquid and radius of the tube respectively, then the values of x , y and z are given by:

- (1) $-1, -1, -1$
- (2) $1, 1, 1$
- (3) $1, -1, -1$
- (4) $-1, -1, 1$

Solution: (3)

$$V_c = \eta^x \rho^y r^z$$

$$\text{Critical velocity is given by } V_c = \frac{R\eta}{2\rho r}$$

$$\text{So, } x = 1$$

$$y = -1$$

$$z = -1$$

26. A nucleus of uranium decays at rest into nuclei of thorium and helium. Then:

- (1) The helium nucleus has more momentum than the thorium nucleus
- (2) The helium nucleus has less kinetic energy than the thorium nucleus
- (3) The helium nucleus has more kinetic energy than the thorium nucleus
- (4) The helium nucleus has less momentum than the thorium nucleus

Solution: (3)



$$KE_{Th} = \frac{p^2}{2m_{Th}}, KE_{\alpha} = \frac{p^2}{2m_{\alpha}}$$

Since m_{α} is less so KE_{α} will be more.

27. An electron moves on a straight line path XY as shown. The abcd is a coil adjacent to the path of electron. What will be the direction of current, if any, induced in the coil?

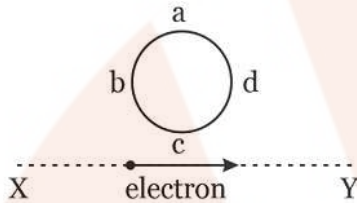

- (1) The current will reverse its direction as the electron goes past the coil
- (2) No current induced
- (3) abcd
- (4) adcb

Solution: (1)

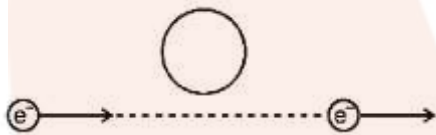

When e^- comes closer the induced current will be anticlockwise

When e^- comes farther induced current will be clockwise.

28. Water rises to a height 'h' in capillary tube. If the length of capillary tube above the surface of water is made less than 'h', then:

- (1) Water rises upto a point a little below the top and stays there
- (2) Water does not rise at all
- (3) Water rises upto the tip of capillary tube and then starts overflowing like a fountain
- (4) Water rises upto the top of capillary tube and stays there without overflowing

Solution: (4)

Water will not overflow but will change its radius of curvature.

29. In an astronomical telescope in normal adjustment a straight black line of the length L is drawn on inside part of objective lens. The eye-piece forms a real image of this line. The length of this image is I. The magnification of the telescope is:

- (1) $\frac{L+I}{L-I}$

- (2) $\frac{L}{I}$
- (3) $\frac{L}{I} + 1$
- (4) $\frac{L}{I} - 1$

Solution: (2)

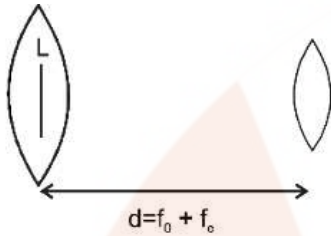

Magnification by eyepiece

$$m = \frac{f}{f+u}$$

$$-\frac{I}{L} = \frac{f_e}{f_e + (-(f_o + f_e))}$$

$$\Rightarrow \frac{I}{L} = \frac{f_e}{f_o}$$

$$\text{m. p.} = \frac{f_o}{f_e} = \frac{L}{I}$$

30. A circuit contains an ammeter, a battery of 30 v and a resistance 40.8 ohm all connected in series. If the ammeter has coil of resistance 480 ohm and a shunt of 20 ohm, the reading in the ammeter will be:

- (1) 2 A
- (2) 1 A
- (3) 0.5 A
- (4) 0.25 A

Solution: (3)

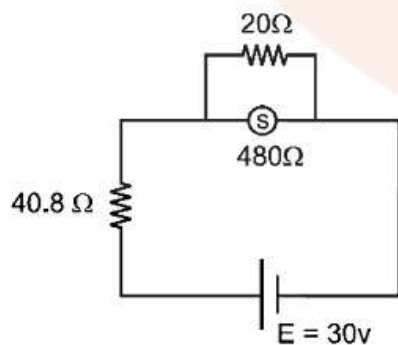

$$\text{Resistance of ammeter} = \frac{480 \times 20}{480 + 20} = 19.2 \Omega$$

$$i = \frac{30}{40.8 + 19.2} = 0.5 \text{ A}$$

Ans. is (3)

31. On a frictionless surfaces, a block of mass M moving at speed v collides elastically with another block of same mass M which is initially at rest. After collision the first block moves at an angle θ to its initial direction and has a speed $\frac{v}{3}$. The second block's speed after the collision is:

- (1) $\frac{3}{\sqrt{2}}v$
- (2) $\frac{\sqrt{3}}{2}v$
- (3) $\frac{2\sqrt{2}}{3}v$
- (4) $\frac{3}{4}v$

Solution: (3)

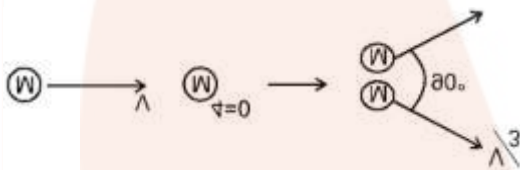

$$\vec{P}_i = \vec{P}_f$$

$$\Rightarrow |P_i| = |P_f| \Rightarrow \sqrt{\left(m \frac{v}{3}\right)^2 + (mV_2)^2}$$

$$V_2 = \frac{2\sqrt{2}}{3}v$$

32. A satellite S is moving in an elliptical orbit around the earth. The mass of the satellite is very small compared to the mass of the earth. Then,
- (1) The linear momentum of S remains constant in magnitude
 - (2) The acceleration of S is always directed towards the centre of the earth
 - (3) The angular momentum of S about the centre of the earth changes in direction, but its magnitude remains constant
 - (4) The total mechanical energy of S varies periodically with time

Solution: (3)

33. In the given figure, a diode D is connected to an external resistance $R = 100 \Omega$ and an e.m.f. of 3.5 V . If the barrier potential developed across the diode is 0.5 V , the current in the circuit will be:

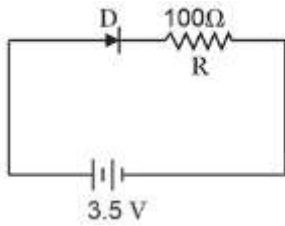

- (1) 20 mA
- (2) 35 mA
- (3) 30 mA
- (4) 40 mA

Solution: (3)

$$\text{Current} = \frac{(3.5 - 0.5)}{100} \text{ A}$$

$$= \frac{3}{100} \text{ A} = 30 \text{ mA}$$

34. A potentiometer wire of length L and a resistance r are connected in series with a battery of e.m.f. E_0 and a resistance r_1 . An unknown e.m.f. E is balanced at a length l of the potentiometer wire. The e.m.f. E will be given by:

- (1) $\frac{E_0 l}{L}$
- (2) $\frac{LE_0 r}{(r+r_1)l}$
- (3) $\frac{LE_0 r}{l r_1}$
- (4) $\frac{E_0 r}{(r+r_1)} \cdot \frac{l}{L}$

Solution: (4)

$$K = \text{potential gradient} = \left(\frac{E_0 r}{r+r_1} \right) \frac{1}{L}$$

$$\text{So } E = K l = \frac{E_0 r l}{(r+r_1) L}$$

35. Two stones of masses m_a and $2m$ are whirled in horizontal circles, the heavier one in a radius $\frac{r}{2}$ and the lighter one in radius r . The tangential speed of lighter stone is n times that of the value of heavier stone when they experience same centripetal forces. The value of n is:

- (1) 4
- (2) 1
- (3) 2
- (4) 3

Solution: (3)

$$F_c = \frac{mv_1^2}{r} = \frac{2mv_2^2}{\left(\frac{r}{2}\right)} = \frac{4mv_2^2}{r}$$

$$\text{So } V_1 = 2V_2$$

36. Two slits in Young's experiment have widths in the ratio 1 : 25. The ratio of intensity at the maxima and minima in the interference pattern, $\frac{I_{\max}}{I_{\min}}$ is:

- (1) $\frac{49}{121}$
- (2) $\frac{4}{9}$
- (3) $\frac{9}{4}$
- (4) $\frac{121}{49}$

Solution: (3)

$$\frac{I_1}{I_2} = \frac{25}{1} \Rightarrow \frac{A_1}{A_2} = \frac{5}{1}$$

$$\frac{A_{\max}}{A_{\min}} = \frac{5 + 1}{5 - 1} = \frac{6}{4} = \frac{3}{2}$$

$$\frac{I_{\max}}{I_{\min}} = \left(\frac{3}{2}\right)^2 = \frac{9}{4}$$

37. The Young's modulus of steel is twice that of brass. Two wires of same length and of same area of cross section, one of steel and another of brass are suspended from the same roof. If we want the lower ends of the wires to be at the same level, then the weights added to the steel and brass wires must be in the ratio of:

- (1) 4 : 1
- (2) 1 : 1
- (3) 1 : 2
- (4) 2 : 1

Solution: (4)

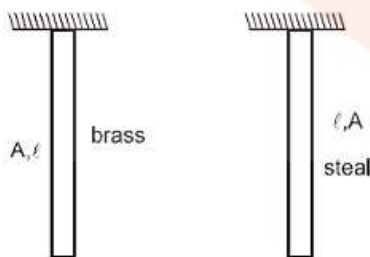

$$Y = \frac{W}{A} \cdot \frac{\ell}{\Delta\ell}$$

$$\text{So } \Delta \ell = \frac{W\ell}{AY}$$

$$\Delta e_1 = \Delta e_2 \quad \frac{w_1 \ell}{AY_1} = \frac{w_2 \ell}{AY_2}$$

$$\frac{w_1}{w_2} = \frac{Y_1}{Y_2} = 2$$

38. The coefficient of performance of a refrigerator is 5. If the temperature inside freezer is -20°C , the temperature of the surrounding to which is rejects heat is:

- (1) 11°C
- (2) 21°C
- (3) 31°C
- (4) 41°C

Solution: (3)

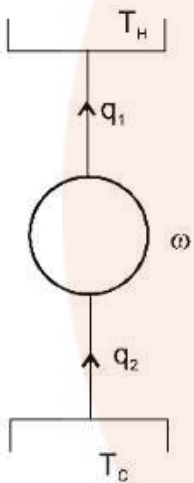

$$\text{cop} = \frac{q_1}{w} = \frac{q_2}{q_1 - q_2} = \frac{T_C}{T_H - T_C} = 5$$

$$T_C = 5T_H - 5T_C$$

$$6T_C = 5T_H$$

$$T_H = \frac{6}{5} \times 253\text{k} = 303.6\text{k} = 30.6^\circ\text{C} = 31^\circ\text{C}$$

39. Light of wavelength 500 nm is incident on a metal with work function 2.258 eV. The de Broglie wavelength of the emitted electron is:

- (1) $\geq 2.8 \times 10^{-9} \text{ m}$
- (2) $\leq 2.8 \times 10^{-12} \text{ m}$
- (3) $< 2.8 \times 10^{-10} \text{ m}$
- (4) $< 2.8 \times 10^{-9} \text{ m}$

Solution: (2)

$$KE_{\max} = \frac{hc}{\lambda} - \Psi$$

$$KE_{\max} = \frac{1240}{500} - 2.82$$

$$KE_{\max} = 2.48 - 2.28 = 0.2 \text{ eV}$$

$$\lambda_{\min} = \frac{h}{\sqrt{2m(KE)_{\max}}} = \frac{\frac{20}{3} \times 10^{-34}}{\sqrt{2 \times 9 \times 10^{-31} \times 0.2 \times 1.6 \times 10^{-19}}}$$

$$\lambda_{\min} = \frac{25}{9} \times 10^{-9} = 2.80 \times 10^{-9} \text{ nm}$$

$$\text{So } \lambda \geq 2.8 \times 10^{-9} \text{ m}$$

40. A source of sound S emitting waves of frequency 100 Hz and an observer O are located at some distance from each other. The source is moving with a speed of 19.4 ms^{-1} at an angle of 60° with the source observer line as shown in the figure. The observer is at rest. The apparent frequency observed by the observer (velocity of sound in air 330 ms^{-1}), is:

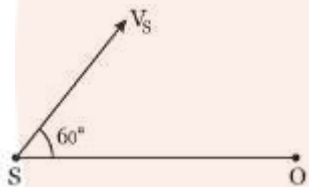

- (1) 106 Hz
- (2) 97 Hz
- (3) 100 Hz
- (4) 103 Hz

Solution: (4)

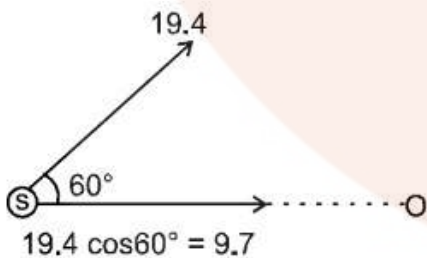

$$t^1 = f_0 \left(\frac{v - v}{v - v_s} \right)$$

$$f^1 = 100 \left(\frac{v - 0}{v - (+9.7)} \right)$$

$$f^1 = 100 \frac{v}{v \left(1 - \frac{9.7}{v}\right)}$$

$$f^1 = 100 \left(1 + \frac{3.7}{330}\right) = 103\text{Hz}$$

41. The value of coefficient of volume expansion of glycerin is $5 \times 10^{-4} \text{K}^{-1}$. The fractional change in the density of glycerin for a rise of 40°C in its temperature is:

- (1) 0.025
- (2) 0.010
- (3) 0.015
- (4) 0.020

Solution: (4)

$$\rho = \rho_0(1 - \gamma\Delta t)$$

$$\frac{\Delta\rho}{\rho_0} = \gamma\Delta T = (5 \times 10^{-4})(40) = 0.02$$

Ans. is (4)

42. The position vector of a particle \vec{R} as a function of time is given by:

$$\vec{R} = 4 \sin(2\pi t) \hat{i} + 4 \cos(2\pi t) \hat{j}$$

Where R is in meters, t is in seconds and \hat{i} and \hat{j} denote unit vectors along x- and y-directions, respectively. Which one of the following statements is wrong for the motion of particle?

- (1) Magnitude of the velocity of particle is 8 meter/second
- (2) Path of the particle is a circle of radius 4 meter.
- (3) Acceleration vector is along $-\vec{R}$.
- (4) Magnitude of acceleration vector is $\frac{v^2}{R}$, where v is the velocity of particle

Solution: (1)

$$x = 4 \sin(2\pi t)$$

$$y = 4 \cos(2\pi t)$$

Squaring and adding

\Rightarrow Circular motion

$$V = \omega R = (2\pi)(4) = 8\pi$$

So, Ans is (1)

43. A plank with a box on it at one end is gradually raised about the other end. As the angle of inclination with the horizontal reaches 30° , the box starts to slip and slides 4.0 m down the plank in 4.0 s. The coefficients of static and kinetic friction between the box and the plank will be, respectively:

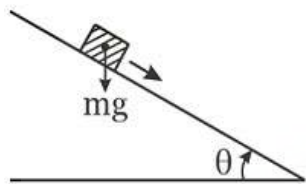

- (1) 0.5 and 0.6
 (2) 0.4 and 0.3
 (3) 0.6 and 0.6
 (4) 0.6 and 0.5

Solution: (4)

$$\mu_s = \tan 30^\circ = \frac{1}{\sqrt{3}} = 0.5$$

$$\mu_s = 0.57 = 0.6$$

$$S = ut + \frac{1}{2}at^2$$

$$4 = \frac{1}{2}a(4)^2 \Rightarrow a = \frac{1}{2} = 0.5$$

$$a = g \sin\theta - \mu_k(g)\cos\theta$$

$$\Rightarrow \mu_k = \frac{0.9}{\sqrt{3}} = 0.5$$

44. In the spectrum of hydrogen, the ratio of the longest wavelength in the Lyman series to the longest wavelength in the Balmer series is:

- (1) $\frac{27}{5}$
 (2) $\frac{5}{27}$
 (3) $\frac{4}{9}$
 (4) $\frac{9}{4}$

Solution: (2)

$$\frac{1}{\lambda_1} = R_e \left(\frac{1}{1^2} - \frac{1}{2^2} \right)$$

$$\frac{1}{\lambda_2} = R_e \left(\frac{1}{2^2} - \frac{1}{3^2} \right)$$

$$\frac{\lambda_1}{\lambda_2} = \frac{5}{27}$$

45. A particle is executing a simple harmonic motion. Its maximum acceleration is α and maximum velocity is β . Then, its time period of vibration will be:

(1) $\frac{\beta^2}{\alpha}$

(2) $\frac{2\pi\beta}{\alpha}$

(3) $\frac{\beta^2}{\alpha^2}$

(4) $\frac{\alpha}{\beta}$

Solution: (2)

$$\omega^2 A = \alpha$$

$$\omega A = \beta$$

$$\Rightarrow \omega = \frac{\alpha}{\beta}$$

$$\Rightarrow T = \frac{2\pi}{\omega} = \frac{2\pi\beta}{\alpha}$$

Biology

46. In the following human pedigree, the filled symbols represents the affected individuals. Identify the type of given pedigree.

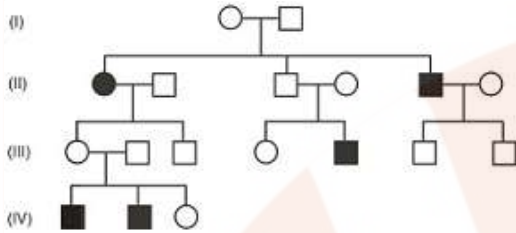

- (1) Autosomal dominant
- (2) X-linked dominant
- (3) Autosomal dominant
- (4) X-linked recessive

Solution: (3)

The given pedigree represents inheritance of Autosomal recessive trait.

47. Which of the following is not a function of the skeletal system?

- (1) Production of body heat
- (2) Locomotion
- (3) Production of erythrocytes
- (4) Storage of minerals

Solution: (1)

Production of body heat is the function of adipose tissue.

48. Destruction of the anterior horn cells of the spinal cord would result in loss of:

- (1) Commissural impulses
- (2) Integrating impulses
- (3) Sensory impulses
- (4) Voluntary motor impulses

Solution: (4)

Anterior horn cells are ventral horn cells of spinal cord which consists of motor neurons.

49. The term "linkage" was coined by:

- (1) G. Mendel
- (2) W. Sutton
- (3) T.H. Morgan
- (4) T. Boveri

Solution: (3)

The term "linkage" was coined by T.H. Morgan.

50. Filiform apparatus is characteristic features of:

- (1) Aleurone cell
- (2) Synergids
- (3) Generative cell
- (4) Nucellar embryo

Solution: (2)

Filiform apparatus is finger like projections in each synergid.

51. Satellite DNA is important because it:

- (1) Does not code for proteins and is same in all members of the population.
- (2) Codes for enzymes needed for DNA replication.
- (3) Codes for proteins needed in cell cycle.
- (4) Shows high degree of polymorphism in population and also the same degree of polymorphism in an individual, which is heritable from parents to children.

Solution: (4)

Satellite DNA are the repetitive DNA which do not code for any protein. They show high degree of polymorphism and form basis of DNA fingerprinting.

Since DNA from every tissue from an individual show the same degree of polymorphism, they become very useful identification tool in forensic applications.

52. The wheat grain has an embryo with one large, shield-shaped cotyledon known as:

- (1) Scutellum
- (2) Coleoptile
- (3) Epiblast
- (4) Coleorhiza

Solution: (1)

Scutellum is the large persistent cotyledon in embryo of wheat grain.

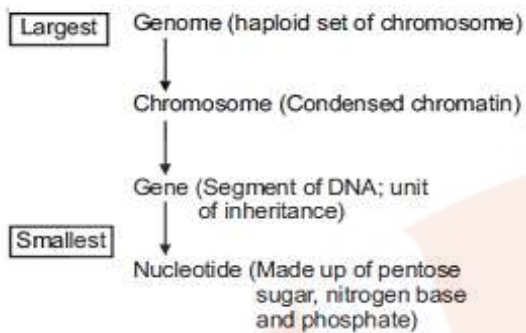

53. Identify the correct order of organization of genetic material from largest to smallest:

- (1) Genome, chromosome, gene, nucleotide
- (2) Chromosome, genome, nucleotide, gene
- (3) Chromosome, gene, genome, nucleotide
- (4) Genome, chromosomes, nucleotide, gene

Solution: (1)

Order of organisation of genetic material

54. Most animals that live in deep oceanic waters are :

- (1) Tertiary consumers
- (2) Detritivores
- (3) Primary consumers
- (4) Secondary consumers

Solution: (2)

Detritivores are an important aspect of many ecosystem. They can live on any soil with organic component, including marine ecosystem.

55. Cell wall is absent in:

- (1) Mycoplasma
- (2) *Nostoc*
- (3) *Aspergillus*
- (4) *Funaria*

Solution: (1)

Mycoplasma is wall-less smallest living organism

56. In which of the following interaction both partners are adversely affected?

- (1) Parasitism

- (2) Mutualism
- (3) Competition
- (4) Predation

Solution: (3)

During competition, both partners are adversely affected.

57. Human urine is usually acidic because

- (1) Potassium and sodium exchange generates acidity
- (2) Hydrogen ions are actively secreted into the filtrate
- (3) The sodium transporter exchanges one hydrogen ion for each sodium ion, in peritubular capillaries.
- (4) Excreted plasma proteins are acidic

Solution: (2)

Tubular secretion maintains the pH and ionic balance of body fluids in which hydrogen ions are actively secreted into the filtrate and bicarbonate ions are reabsorbed.

58. Match the following list of microbes and their importance:

(a)	<i>Sacharomyces cerevisiae</i>	(i)	Production of immunosuppressive agents
(b)	<i>Monascus purpureus</i>	(ii)	Ripening of Swiss cheese
(c)	<i>Trichoderma polysporum</i>	(iii)	Commercial production of ethanol
(d)	<i>Propionibacterium shermanii</i>	(iv)	Production of blood-cholesterol lowering agents

- | | (a) | (b) | (c) | (d) |
|-----|-------|-------|------|-------|
| (1) | (iv) | (ii) | (i) | (iii) |
| (2) | (iii) | (i) | (iv) | (ii) |
| (3) | (iii) | (iv) | (i) | (ii) |
| (4) | (iv) | (iii) | (ii) | (i) |

Solution: (3)

Microbes	Importance
(1) Sacharomyces	– Commercial production of erevisiae ethanol.
(2) Monascus	– Production of blood purpureus cholesterol lowering agents
(3) Trichoderma polysporum	– Production of immunosuppressive agents
(4) Propionibacterium sharmanii	– Ripening of Swiss cheese

59. The body cells in cockroach discharges their nitrogenous waste in the Haemolymph mainly in the form of :

- (1) Urea
- (2) Calcium carbonate

- (3) Ammonia
- (4) Potassium urate

Solution: (4)

Malpighian tubules keep floating in haemolymph from where potassium waste diffuses into the tubule. Urate crystals are crystals of uric acid.

60. In which of the following both pairs have correct combination?

(1)	Gaseous nutrient cycle	Nitrogen and Sulphur
	Sedimentary nutrient cycle	Carbon and phosphorus
(2)	Gaseous nutrient cycle	Sulphur and Phosphorus
	Sedimentary nutrient cycle	Carbon and Nitrogen
(3)	Gaseous nutrient cycle	Carbon and Nitrogen
	Sedimentary nutrient cycle	Sulphur and phosphorus
(4)	Gaseous nutrient cycle	Carbon and Sulphur
	Sedimentary nutrient cycle	Nitrogen and Phosphorus

Solution: (3)

When *Agrobacterium tumifaciens* infects the host plant, it will transfer a part of DNA called t-DNA without any human interference so called natural genetic engineer.

61. Which one is a **wrong** statement?

- (1) Haploid endoperm is typical feature of gymnosperms
- (2) Brown algae have chlorophyll a and c, and fucoxanthin
- (3) Archegonia are found in Bryophyta, Pteridophyta and Gymnosperms
- (4) *Mucor* has biflagellate zoospores

Solution: (4)

Mucor has non-motile spore i.e. sporangiospores.

62. Match the columns and identify the correct option.

	Column I		Column II
(a)	Thylakoids	(i)	Disc-Shaped sacs in Golgi apparatus
(b)	Cristae	(ii)	Condensed structure of DNA
(c)	Cisternae	(iii)	Flat membranous sacs in stroma
(d)	Chromatin	(iv)	Infoldings in mitochondria

- | | (a) | (b) | (c) | (d) |
|-----|-------|-------|------|------|
| (1) | (iii) | (i) | (iv) | (ii) |
| (2) | (iii) | (iv) | (ii) | (i) |
| (3) | (iv) | (iii) | (i) | (ii) |
| (4) | (iii) | (iv) | (i) | (ii) |

Solution: (2)

Thylakoids – Flat membranous sacs in stroma of chloroplast.

Cristae – Infoldings in mitochondria

Cisternae – Disc-shaped sacs in golgiapparatus

Chromatin – Condensed structure of DNA.

63. If you suspect major deficiency of antibodies in a person, to which of the following would you like for confirmation evidence?

- (1) Haemocytes
- (2) Serum globulins
- (3) Fibrinogen in plasma
- (4) Serum albumins

Solution: (3)

Antibodies are present in serum. They are glycoproteins and also called gammaglobulins synthesized in lymph nodes.

64. The imperfect fungi which are decomposers of litter and help in mineral cycling belong to :

- (1) Phycomcetes
- (2) Ascomycetes
- (3) Deuteromycetes
- (4) Basidiomycetes

Solution: (3)

Deuteromycetes - Imperfect fungi which are decomposers of litter and help in mineral cycling.

65. The oxygen evolved during photosynthesis comes from water molecules. Which one of the following pairs of elements is involved in this reaction?

- (1) Magnesium and Molybdenum
- (2) Magnesium and Chlorine
- (3) Manganese and chlorine
- (4) Manganese and Potassium

Solution: (3)

Manganese, chlorine and calcium help in photolysis of water during light reaction of photosynthesis.

66. Body having meshwork of cells, internal cavities lined with food filtering flagellated cells and indirect development are the characteristics of phylum:

- (1) Mollusca
- (2) Protozoa
- (3) Coelenterata
- (4) Porifera

Solution: (4)

In poriferans, the body is loose aggregate of cells (meshwork of cells). Internal cavities and canals are lined with food filtering flagellated cells i.e. choanocyte/collar cell. Choanocytes help in filter feeding.

67. Root pressure is usually acidic because

- (1) Passive absorption
- (2) Increase in transpiration
- (3) Active absorption
- (4) Low osmotic potential in soil

Solution: (3)

As various ions from the soil are actively transported into the vascular tissues of the roots, water follows and increases the pressure inside the xylem i.e., root pressure (positive pressure).

68. The enzyme that is not present in succus entericus is:

- (1) Nucleosidase
- (2) Lipase
- (3) Maltase
- (4) Nucleases

Solution: (4)

Succus entericus is intestinal juice contains maltase, lipase, nucleosidase. Nucleases are the enzymes of pancreatic juice.

69. Metagenesis refers to :

- (1) Occurrence a drastic change in form during post-embryonic development
- (2) Presence of a segmented body and parthenogenetic mode of reproduction
- (3) Presence of different morphic forms
- (4) Alternation of generation between asexual and sexual phases of an organism

Solution: (4)

In coelenterates, metagenesis is alternation of generation between polyp and medusa. Polyp reproduces asexually by budding to form medusa and medusa reproduces sexually to form polyp.

70. A protoplast is a cell :

- (1) Undergoing division
- (2) Without cell wall
- (3) Without plasma membrane
- (4) Without nucleus

Solution: (2)

Plant cell — Cell wall = Protoplast

71. The DNA molecule to which the gene of interest is integrated for cloning is called :

- (1) Temple
- (2) Carrier
- (3) Transformer
- (4) Vector

Solution: (4)

The DNA molecule to which the gene of interest is integrated for cloning is called vector.

72. Which of the following structure is not found in a prokaryotic cell?

- (1) Mesosome
- (2) Plasma membrane
- (3) Nuclear envelope
- (4) Ribosome

Solution: (3)

True nucleus is absent in prokaryotic cell.

73. The structures that help some bacteria to attach to rocks and/or host tissue are :

- (1) Mesosomes
- (2) Holdfast
- (3) Rhizoids
- (4) Fimbriae

Solution: (4)

Fimbriae - Hollow tubular surface appendages, present in bacterial cell, which help in attachment to rocks and / or host tissues.

74. Which one of the following hormones is not involved in sugar metabolism?

- (1) Insulin
- (2) Glucagon
- (3) Cortisone
- (4) Aldosterone

Solution: (1)

Mineralocorticoid (Aldosterone) has no role in sugar metabolism. It helps in salt metabolism.

75. In photosynthesis, the light-independent reactions take place at :

- (1) Photosystem II
- (2) Stromal matrix
- (3) Thylakoid lumen
- (4) Photosystem I

Solution: (2)

Light-independent reactions or Dark reactions occur in stroma/ stromal matrix. During these reactions carbon dioxide is reduced to carbohydrates.

76. The chitinous exoskeleton of arthropods is formed by the polymerization of :

- (1) N-acetyl glucosamine
- (2) Lipoglycans
- (3) Keratin sulphate and chondroitin sulphate
- (4) D- glucosamine

Solution: (1)

Exoskeleton of arthropods is made up of chitin. Chitin is a polymer of N-acetyl glucosamine.

77. Select the wrong statement :

- (1) The term '*contagium vivum fluidum*' was coined by M.W. Beijerinck
- (2) Mosaic disease in tobacco and AIDS in human being are caused by viruses
- (3) The viroids were discovered by D.J. Jvanowski
- (4) W.M. Stanley showed that viruses could be crystallized

Solution: (3)

The viroids were discovered by T.O. Diener.

78. Among China rose, mustard, brinjal, potato, guava, cucumber, onion and tulip, how many plants have superior ovary?

- (1) Three
- (2) Four
- (3) Five
- (4) Six

Solution: (4)

Superior ovary is found in plants i.e. china rose, mustard, brinjal, potato, onion and tulip.

79. In angiosperms, microsporogenesis and megasporogenesis:

- (1) Involve meiosis
- (2) Occur in ovule
- (3) Occur in anther
- (4) Form gametes without further divisions

Solution: (1)

In angiosperms, microsporogenesis and megasporogenesis involve meiosis

80. Cellular organelles with membranes are:
- (1) Endoplasmic reticulum, ribosomes and nuclei
 - (2) Lysosomes, Golgi apparatus and mitochondria
 - (3) Nuclei, ribosomes and mitochondria
 - (4) Chromosomes, ribosomes and endoplasmic reticulum

Solution: (2)

Lysosomes, Golgi apparatus and mitochondria are membrane bound organelles.

81. Which one of the following is not applicable to RNA?
- (1) Heterocyclic nitrogenous bases
 - (2) Chargaff's rule
 - (3) Complementary base pairing
 - (4) 5' phosphoryl and 3' hydroxyl ends

Solution: (2)

Chargaff's rule is applicable only for DNA.

82. Which of the following are most suitable indicators of SO_2 Pollution in the environment?
- (1) Algae
 - (2) Fungi
 - (3) Lichens
 - (4) Conifers

Solution: (3)

Lichens do not grow in SO_2 polluted regions therefore they indicate SO_2 pollution in air. Phycobionts of lichen are sensitive to SO_2

83. Acid rain is caused by increase in the atmospheric concentration of :
- (1) CO_2 and CO
 - (2) O_3 and dust
 - (3) SO_2 and NO_2
 - (4) SO_3 and CO

Solution: (3)

During rainfall, SO_2 and NO_2 can decrease the pH of rain water.

84. Which of the following immunoglobulins does constitute the largest percentage in human milk?
- (1) IgA
 - (2) IgG
 - (3) IgD
 - (4) IgM

Solution: (1)

IgA is present in external body secretion including colostrum and milk. They provide naturally acquired passive immunity to child.

85. Which of the following diseases is caused by a protozoan?

- (1) Babesiosis
- (2) Blastomycosis
- (3) Syphilis
- (4) Influenza

Solution: (1)

Babesiosis is a disease caused by a protozoan, *Babesia bigemina*. The vector is tick, so disease is also called tick fever in cattle.

86. Outbreeding is an important strategy of animal husbandry because it :

- (1) Is useful in overcoming inbreeding depression
- (2) Expose harmful recessive genes that are eliminated by selection.
- (3) Helps in accumulation of superior genes.
- (4) Is useful in producing purelines of animals

Solution: (1)

A single outcross (a type of outbreeding) is useful in overcoming inbreeding depression.

87. Which one of the following animals has two separate circulatory pathways?

- (1) Whale
- (2) Shark
- (3) Frog
- (4) Lizard

Solution: (1)

Whale is a mammal which has 4 chambered heart, so has complete separation of oxygenated and deoxygenated blood. Whale have double circulatory pathways: Systemic and pulmonary circulation.

88. Name the pulmonary disease in which alveolar surface area involved in gas exchange is drastically reduced due to damage in the alveolar walls.

- (1) Pneumonia
- (2) Asthama
- (3) Pleurisy
- (4) Emphysema

Solution: (4)

Emphysema is mainly due to cigarette smoking in which the walls of alveoli are damaged that leads to reduction in surface area for gaseous exchange.

89. A childless couple can be assisted to have a child through a technique called GIFT. The full form of this techniques is :

- (1) Gamete internal fertilization and transfer
- (2) Germ cell internal fallopian transfer
- (3) Gamete inseminated fallopian transfer
- (4) Gamete intra fallopian transfer

Solution: (4)

GIFT - Gamete intra fallopian transfer

90. A gene showing codominance has :

- (1) Alleles that are recessive to each other
- (2) Both alleles independently expressed in the heterozygote
- (3) One allele dominant on the other
- (4) Alleles tightly linked on the same chromosome

Solution: (1)

Both alleles are independently expressed in heterozygote during codominance.

91. Doctors use stethoscope to hear the sounds produced during each cardiac cycle. The second sound is heard when :

- (1) Semilunar valves close down after the blood flows into vessels from ventricles
- (2) AV node receives signal from SA node
- (3) AV valves open up
- (4) Ventricular walls vibrate due to gushing in of blood from atria

Solution: (1)

Second heart sound is 'DUP' which is produced during early ventricular diastole due to the sharp closure of semilunar valves.

92. Read the different components from (a) to (d) in the list given below and tell the correct order of the components with reference to their arrangement from outer side to inner side in a woody dicot stem :

- (a) Secondary cortex
- (b) Wood
- (c) Secondary phloem
- (d) Phellem

- (1) (d), (a), (c), (b)
- (2) (d), (c), (a), (b)
- (3) (c), (d), (b), (a)
- (4) (a), (b), (d), (c)

Solution: (1)

Sequence of different components of woody dicot stem from outside to inner side is:

93. Which one of the following hormones though synthesised elsewhere, is stored and release by the master gland?

- (1) Prolactin
- (2) Melanocyte stimulating hormone
- (3) Antidiuretic hormone
- (4) Luteinizing hormone

Solution: (3)

Antidiuretic hormone is synthesized by the neurons of hypothalamus and stored in axon endings of posterior lobe of pituitary and released into the blood by posterior pituitary.

94. The wings of a bird and the wings of an insect are :

- (1) Phylogenetic structures and represent divergent evolution
- (2) Homologous structures and represent convergent evolution
- (3) Homologous structures and represent divergent evolution
- (4) Analogous structures and represent convergent evolution

Solution: (4)

The wings of a bird and an insect are analogous structure which differ in structure and origin but perform similar functions and represent convergent evolution.

95. Which of the following pairs is not correctly matched?

	Mode of Reproduction	Example
(1)	Binary fission	<i>Sargassum</i>
(2)	Conidia	<i>Penicillium</i>
(3)	Offset	Water hyacinth
(4)	Rhizome	Banana

Solution: (1)

Mode of Reproduction

Example

- | | |
|--------------------|----------------------------------|
| (1) Rhizome | Banana |
| (2) Binary fission | <i>Saecharomyces</i> (Yeast) |
| (3) Conidia | <i>Penicillium</i> (Ascomycetes) |
| (4) Offset | Water hyacinth |

96. In is classic experiments on pea plants, Mendel did not use :

- (1) Seed shape
- (2) Flower position
- (3) Seed colour
- (4) Pod length

Solution: (4)

Mendel did not selected Pod length as a character for study

97. The function of the gap junction is to :

- (1) Separate two cells from each other
- (2) Stop substance from leaking across a tissue
- (3) Performing cementing to keep neighbouring cell together
- (4) Facilitate communication between adjoining cells by connecting the cytoplasm for rapid transfer of ions, small molecules and some large molecules.

Solution: (4)

Gap junctions are communicating junctions in animals which facilitates communication between two adjoining cells by protein bridges for rapid transfer of ions, small molecules and large molecules.

98. Eutrophication of water bodies leading to killing of fishes is mainly due to non-availability of:

- (1) Essential Minerals
- (2) Oxygen
- (3) Food
- (4) Light

Solution: (2)

During eutrophication of water bodies, BOD level increases due to rapid growth of microbes.

99. In human females, meiosis-II is not completed until?

- (1) Uterine implantation
- (2) Birth
- (3) Puberty
- (4) Fertilization

Solution: (4)

In human females, meiosis II is completed after the entry of sperm into the cytoplasm of secondary oocyte at the time of fertilisation leading to the formation of ovum and IInd polar body.

100. The species confined to a particular region and not found elsewhere termed as :

- (1) Endemic
- (2) Rare
- (3) Keystone
- (4) Alien

Solution: (1)

The species confined to a particular region and not found elsewhere is termed as Endemic.

101. The UN conference Parties in climate change in the year 2012 was held at :

- (1) Lima
- (2) Warsaw
- (3) Durban
- (4) Doha

Solution: (4)

The United Nations Climate change conferences are yearly conferences and are known as Conference of the Parties (COP).

102. Which of the following layers in an antral follicle is acellular?

- (1) Stroma
- (2) Zona pellucida
- (3) Granulosa
- (4) Theca interna

Solution: (2)

Zona pellucida is non-cellular membrane made up of glycoproteins. It is secreted by secondary oocyte in Graafian follicle.

103. During biological nitrogen fixation, inactivation of nitrogenase by oxygen poisoning is prevented by:

- (1) Carotene
- (2) Cytochrome
- (3) Leghaemoglobin
- (4) Xanthophyll

Solution: (3)

During Biological nitrogen fixation, inactivation of nitrogenase by oxygen poisoning is prevented by pink coloured oxygen scavenger pigment leghaemoglobin.

104. Which of the following events is not associated with ovulation in human female?

- (1) Release of secondary oocyte
- (2) LH surge
- (3) Decrease in estradiol
- (4) Full development of Graafian follicle

Solution: (3)

In 28 days reproductive cycle, ovulation occurs on 14th day due to LH surge. In the mid cycle, the level of FSH and estrogen are also high. The female gamete is released from the ovary in secondary oocyte stage after completing meiosis I.

105. Arrange the following events of meiosis in correct sequence :

- (a) Crossing over
- (b) Synapsis
- (c) Terminalisation of chiasmata

(d) Disappearance of nucleolus

- (1) (a), (b), (c), (d)
- (2) (b), (c), (d), (a)
- (3) (b), (a), (d), (c)
- (4) (b), (a), (c), (d)

Solution: (4)

The sequence of event during meiosis are

- (1) Synapsis (Zygotene)
- (2) Crossing over (Pachytene)
- (3) Terminalisation of chiasmata
- (4) Disappearance of nucleolus

106. Which of the following joints would allow no movement?

- (1) Synovial joint
- (2) Ball and socket joint
- (3) Fibrous joint
- (4) Cartilaginous joint

Solution: (3)

Fibrous joint are immovable joints where two bones are connected with the help of fibrous connective tissue.

107. Flowers are unisexual in

- (1) China rose
- (2) Onion
- (3) Pea
- (4) Cucumber

Solution: (4)

Flowers are unisexual in cucumber.
[Family - Cucurbitaceae]

108. A colour blind man marries a women with normal sight who has no history of colour blindness in her family. What is the probability of their grandson being colour blind?

- (1) Nil
- (2) 0.25
- (3) 0.5
- (4) 1

Solution: (3)

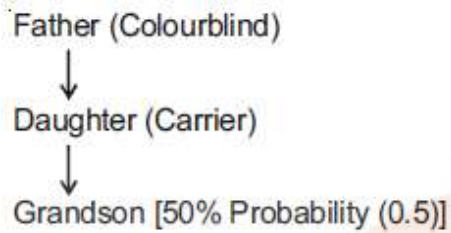

109. The cutting of DNA at specific location became possible with the discovery of :

- (1) Selectable markers
- (2) Ligases
- (3) Restriction enzymes
- (4) Probes

Solution: (3)

The cutting of DNA at specific locations became possible with the discovery of restriction enzymes called molecular scissors or knife.

110. Roots play insignificant role in absorption of water in:

- (1) Pea
- (2) Wheat
- (3) Sunflower
- (4) Pistia

Solution: (4)

Pistia - roots are poorly developed as it is free floating hydrophyte.

111. Male gametophyte in angiosperms producers :

- (1) Single sperm and two vegetative cells
- (2) Three sperms
- (3) Two sperms and a vegetative cell
- (4) Single sperm and a vegetative cell

Solution: (3)

In angiosperms, pollen grain is first male gametophyte. Pollen grain divides into generative cell and vegetative cell. Generative cell further divides into two sperms.

112. In which group of organisms the cell walls form two thin lapping shells which fit together

- (1) Dinoflagellates
- (2) Slime moulds
- (3) Chrysophytes
- (4) Euglenoids

Solution: (3)

Chrysophytes are photosynthetic protists. They have overlapping cell wall like soap box.

113 . Coconut water from a tender coconut is :

- (1) Innermost layers of the seed coat
- (2) Degenerated nucellus
- (3) Immature embryo
- (4) Free nuclear endosperm

Solution: (4)

Coconut water is free nuclear endosperm.

114. A column of water within xylem vessels of tall trees does not break under its weight because of :

- (1) Lignification of xylem vessels
- (2) Positive root pressure
- (3) Dissolved sugars in water
- (4) Tensile strength of water

Solution: (4)

The column of water within Xylem vessel of tall trees does not break under its weight due to high tensile strength of water. Tensile strength is the ability to resist pulling forces.

115. Chromatophores take part in :

- (1) Movement
- (2) Respiration
- (3) Photosynthesis
- (4) Growth

Solution: (3)

Chromatophores are photosynthetic apparatus in prokaryotes.

116. In mammalian eye, the 'fovea' is the center of the visual field, where :

- (1) Only rods are present
- (2) More rods than cones are found
- (3) High density of cones occur, but has no rods
- (4) The optic nerve leaves the eye

Solution: (3)

Fovea has highest visual acuity which has only cone cells and no rod cells.

117. Industrial melanism is an example of :

- (1) Mutation
- (2) Neo Lamarckism
- (3) Neo Darwinism
- (4) Natural selection

Solution: (4)

Industrial melanism is an example of natural selection.

118. Which of the following biomolecules does have a phosphodiester bond?

- (1) Amino acids in a polypeptide
- (2) Nucleic acids in a nucleotide
- (3) Fatty acids in a diglyceride
- (4) Monosaccharides in a polysaccharide

Solution: (2)

Phosphodiester bond is formed between two nucleotides of nucleic acid.

119. An association of individuals of different species living in the same habitat and having functional interactions is:

- (1) Ecosystem
- (2) Population
- (3) Ecological niche
- (4) Biotic community

Solution: (4)

Populations of different species occurring in a habitat comprise the biotic community

120. Golden rice is a genetically modified crop plant where the incorporated gene is meant for biosynthesis of :

- (1) Omega 3
- (2) Vitamin A
- (3) Vitamin B
- (4) Vitamin C

Solution: (2)

Golden rice is nutritionally enriched rich and is meant for biosynthesis of vitamin A.

121. The introduction of t-DNA into plants involves :

- (1) Exposing the plants to cold for a brief period
- (2) Allowing the plant roots to stand in water
- (3) Infection of the plant by *Agrobacterium tumefaciens*
- (4) Altering the pH of the soil, then heat-shocking the plants

Solution: (3)

When *Agrobacterium tumefaciens* infects the host plant, it will transfer a part of DNA called t-DNA without any human interference so called natural genetic engineer.

122. Auxin can be bioassayed by:

- (1) Potometer
- (2) Lettuce hypocotyl elongation
- (3) *Avena* coleoptile curvature
- (4) Hydroponics

Solution: (3)

Avena coleoptile curvature test is the bioassay for auxin.

123. Pick up the **wrong** statement :

- (1) Some fungi are edible
- (2) Nuclear membrane is present in Monera
- (3) Cell wall is absent in Animalia
- (4) Protista have photosynthetic and heterotrophic modes of nutrition

Solution: (2)

The members of kingdom-Monera are prokaryotes they lack nuclear membrane.

124. Ectopic pregnancies are referred to as :

- (1) Implantation of defective embryo in the uterus
- (2) Pregnancies terminated due to hormonal imbalance
- (3) Pregnancies with genetic abnormality.
- (4) Implantation of embryo at side other than uterus

Solution: (4)

Any extra uterine pregnancy is ectopic pregnancy. Implantation can occur in the wall of abdominal cavity, ovaries but 90-95% of ectopic pregnancies are tubal pregnancy where implantation occurs in fallopian tube.

125. Axile placentation is present in :

- (1) *Pea*
- (2) *Argemone*
- (3) *Dianthus*
- (4) Lemon

Solution: (4)

The number of ovules are arranged on central axis in multilocular ovary.

126. The primary dentition in human differs from permanent dentition in not having one of the following type of teeth :

- (1) Molars
- (2) Incisors
- (3) Canine
- (4) Premolars

Solution: (4)

Dental formula of human adult (permanent dentition) = $\frac{2123}{2123}$.

Dental formula of child (primary dentition) = $\frac{2102}{2102}$

127. Which one of the following fruits is parthenocarpic?

- (1) Jackfruit
- (2) Banana
- (3) Brinjal
- (4) Apple

Solution: (3)

Formation of fruit without fertilisation is called parthenocarpy. Banana is a parthenocarpic fruit therefore seedless.

128. Balbiani rings are sites of:

- (1) Polysaccharide synthesis
- (2) RNA and protein synthesis
- (3) Lipid synthesis
- (4) Nucleotide synthesis

Solution: (2)

Balbiani rings are the large chromosome puff of polytene chromosomes. These are the sites of RNA and protein synthesis.

129. A pleiotropic gene

- (1) Controls a trait only in combination with another gene
- (2) Controls multiple traits in an individual
- (3) Is expressed only primitive plants
- (4) Is a gene evolved during Pliocene

Solution: (2)

The gene which controls multiple traits in an individual.

130. Grafted kidney may be rejected in a patient due to:

- (1) Passive immune response
- (2) Innate immune response

- (3) Humoral immune response
- (4) Cell-mediated immune response

Solution: (4)

Cell mediated immunity (CMI) is responsible for graft rejection.

131. During ecological succession :

- (1) The numbers and types of animals remain constant
- (2) The changes lead to a community that is in near equilibrium with the environment and is called pioneer community
- (3) The gradual and predictable change in species composition occurs in a given area
- (4) The establishment of a new biotic community is very fast in its primary phase

Solution: (3)

Ecological succession involves gradual and fairly predictable change in the species composition of a given area.

132. Which of the following are not membrane – bound?

- (1) Lysosomes
- (2) Mesosomes
- (3) Vacuoles
- (4) Ribosomes

Solution: (4)

Ribosomes are made up of r-RNA and proteins.

133. Increase in concentration of the toxicant at successive trophic levels is known as :

- (1) Biotransformation
- (2) Biogeochemical cycling
- (3) Biomagnification
- (4) Biodeterioration

Solution: (3)

Increase in concentration of toxic substances in successive trophic level.

134. A jawless fish, which lays eggs in fresh water and whose ammocoetes larvae after metamorphosis return to the ocean is :

- (1) *Neomyxine*
- (2) *Petromyzon*
- (3) *Eptatretus*
- (4) *Myxine*

Solution: (2)

Petromyzon (Lamprey) is a migratory marine water jawless fish which shows anadromous migration. It spawns in fresh water, stops feeding and dies. Its larva (*Ammocoetes*) after metamorphosis will return to ocean.

135. Choose the wrong statement:

- (1) Morels and truffles are poisonous mushrooms
- (2) Yeast is unicellular and useful in fermentation
- (3) Penicillium is multicellular and produces antibiotics
- (4) Neurospora is used in the study of biochemical genetics

Solution: (1)

Morels and truffles are edible fungi belong to class ascomycetes.

Chemistry

136. Strong reducing behaviour of H_3PO_2 is due to:

- (1) High electron gain enthalpy of phosphorus
- (2) High oxidation state of phosphorus
- (3) Presence of two $-\text{OH}$ groups and one $\text{P}-\text{H}$ bond
- (4) Presence of one $-\text{OH}$ group and two $\text{P}-\text{H}$ bonds

Solution: (4) Strong reducing behaviour of H_3PO_2

All oxy-acid of phosphorus which contain $\text{P}-\text{H}$ bond act as reductant.

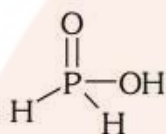

Presence of one $-\text{OH}$ group and two $\text{P}-\text{H}$ bonds.

137. The stability of +1 oxidation state among Al, Ga, In and Tl increases in the sequence:

- (1) $\text{Al} < \text{Ga} < \text{In} < \text{Tl}$
- (2) $\text{Tl} < \text{In} < \text{Ga} < \text{Al}$
- (3) $\text{In} < \text{Tl} < \text{Ga} < \text{Al}$
- (4) $\text{Ga} < \text{In} < \text{Al} < \text{Tl}$

Solution: (1) Stability of +1 oxidation state due to inert pair effect $\text{Tl} < \text{In} < \text{Ga} < \text{Al}$.

138. The oxidation of benzene by V_2O_5 in the presence of air produces:

- (1) Maleic anhydride
- (2) Benzoic acid
- (3) Benzaldehyde
- (4) Benzoic anhydride

Solution: (1)

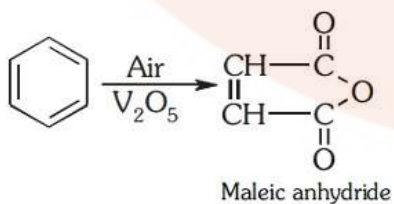

139. If the equilibrium constant for $\text{N}_2(\text{g}) + \text{O}_2(\text{g}) \rightleftharpoons 2\text{NO}(\text{g})$ is K , the equilibrium constant for $\frac{1}{2}\text{N}_2(\text{g}) + \frac{1}{2}\text{O}_2(\text{g}) \rightleftharpoons \text{NO}(\text{g})$ will be:

- (1) $\frac{1}{2}K$
- (2) K
- (3) K^2
- (4) $K^{\frac{1}{2}}$

Solution: (4)

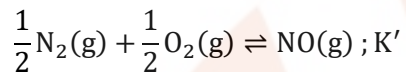
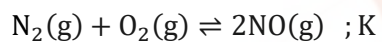

$$K = \frac{[\text{NO}]^2}{[\text{N}_2] [\text{O}_2]}$$

$$K' = \frac{\text{NO}}{[\text{N}_2]^{1/2}[\text{O}_2]^{1/2}}$$

$$\therefore K' = \sqrt{K}$$

140. Gadolinium belongs of 4f series. Its atomic number is 64. Which of the following is the correct electronic configuration of gadolinium?

- (1) $[\text{Xe}]4f^95s^1$
- (2) $[\text{Xe}]4f^75d^16s^2$
- (3) $[\text{Xe}]4f^65d^26s^2$
- (4) $[\text{Xe}]4f^86d^2$

Solution: (2) ${}_{64}\text{Gd} = {}_{54}[\text{Xe}]6s^2 4f^7 5d^1$

141. The following reaction

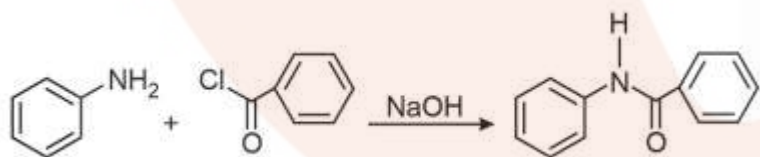

Is known by the name:

- (1) Perkin's reaction
- (2) Acetylation reaction
- (3) Schotten-Baumen reaction
- (4) Friedel-Craft's reaction

Solution: (3)

Benzoylation of aniline is an example of Schotten-Bauman reaction.

142. What is the mass of the precipitate formed when 50 mL of 16.9% solution of AgNO_3 is mixed with 50 mL of 5.8% NaCl solution?

(Ag = 107.8, N = 14, O = 16, Na = 23, Cl = 35.5)

- (1) 3.5 g
- (2) 7 g
- (3) 14 g
- (4) 28 g

Solution: (2) 16.9 g AgNO_3 is present in 100 mL solution.

\therefore 8.45 g AgNO_3 is present in 50 mL solution

5.8 g NaCl is present in 100 mL solution

\therefore 2.9 g NaCl is present in 50 mL solution

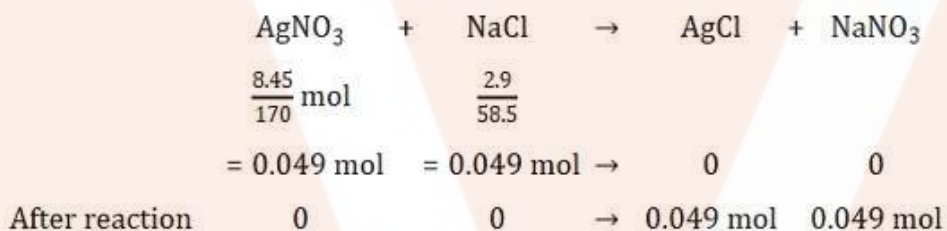

Mass of AgCl precipitated

$$= 0.049 \times 143.5 \text{ g}$$

$$= 7 \text{ g AgCl}$$

143. What is the pH of the resulting solution when equal volumes of 0.1 M NaOH and 0.01 M HCl are mixed?

- (1) 2.0
- (2) 7.0
- (3) 1.04
- (4) 12.65

Solution: (4) $N_1V_1 - N_2V_2 = N.V.$

$$0.1 \times 1 - 0.01 \times 1 = N \times 2$$

$$[\text{OH}^-] = N_R = 0. \frac{09}{2} = 0.045 \text{ N}$$

$$\text{pOH} = -\log(0.045) = 1.35$$

$$\therefore \text{pH} = 14 - \text{pOH} = 14 - 1.35 = 12.65$$

144. Method by which Aniline cannot be prepared is:

- (1) Degradation of benzamide with bromine in alkaline solution

- (2) Reduction of nitrobenzene with H_2/Pd in ethanol.
- (3) Potassium salt of phthalimide treated with chlorobenzene followed by hydrolysis with aqueous NaOH solution.
- (4) Hydrolysis of phenylisocyanide with acidic solution

Solution: (3)

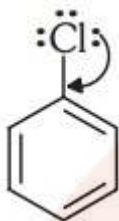

Due to resonance C – Cl bond acquires double bond character.

145. If Avogadro number N_A , is changed from $6.022 \times 10^{23} \text{ mol}^{-1}$ to $6.022 \times 10^{20} \text{ mol}^{-1}$, this would change:

- (1) The mass of one mole of carbon
- (2) The ratio of chemical species to each other in a balanced equation.
- (3) The ratio of elements to each other in compound.
- (4) The definition of mass in units of grams

Solution: (1)

\therefore Mass of 1 mol (6.022×10^{23} atoms) of carbon = 12g

If Avogadro Number (N_A) is changed then mass of 1 mol (6.022×10^{20} atom) of carbon

$$= \frac{12 \times 6.022 \times 10^{20}}{6.022 \times 10^{23}} = 12 \times 10^{-3} \text{ g}$$

146. The variation of the boiling points of the hydrogen halides is in the order $HF > HI > HBr > HCl$. What explains the higher boiling point of hydrogen fluoride?

- (1) There is strong hydrogen bonding between HF molecules.
- (2) The bond energy of HF molecules is greater than in other hydrogen halides.
- (3) The effect of nuclear shielding is much reduced in fluorine which polarizes the HF molecule.
- (4) The electronegativity of fluorine is much higher than for other elements in the group.

Solution: (1)

Due to strong H-bonding in HF molecule, boiling point is highest for HF.

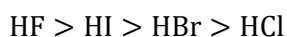

147. The number of structural isomers possible from the molecular formula C_3H_9N is:

- (1) 5
- (2) 2

(3) 3

(4) 4

Solution: (1)

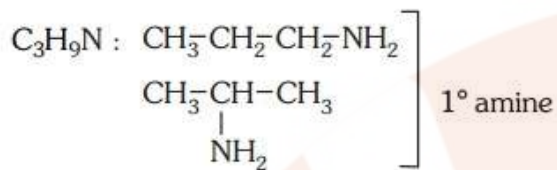

{CH₃ - CH₂ - NH - CH₃} 2° amine

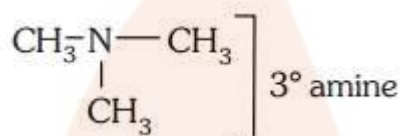

148. Which of the statements given below is incorrect?

- (1) O₃ molecule is bent.
- (2) ONF is isoelectronic with O₂N⁻
- (3) OF₂ is an oxide of fluorine.
- (4) Cl₂O₇ is an anhydride of perchloric acid

Solution: (3)

i. No. of electron in ONF = 24

No. of electron in NO₂⁻ = 24

Both are isoelectronic.

ii. OF₂ is a fluoride of oxygen not oxide of fluorine because EN of fluorine is more than oxygen.

OF₂ = Oxygen difluoride

iii. Cl₂O₇ is an anhydride of perchloric acid.

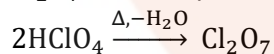

iv. O₃ molecules is bent shape.

149. The formation of the oxide ion, O²⁻(g), from oxygen atom requires first an exothermic and then an endothermic step as shown in below:

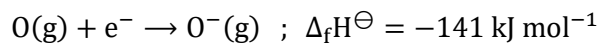

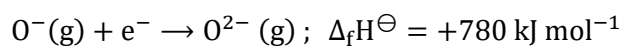

Thus process of formation of O^{2-} in gas phase is unfavourable though O^{2-} is isoelectronic with neon. It is due to the fact that,

- (1) O^- ion has comparatively smaller size than oxygen atom.
- (2) Oxygen is more electronegative.
- (3) Addition of electron in oxygen results in larger size of the ion
- (4) Electron repulsion outweighs the stability gained by achieving noble gas configuration.

Solution: (4)

150. In the reaction with HCl, an alkene reacts in accordance with the Markovnikov's rule, to give a product 1-chloro-1-methylcyclohexane. The possible reaction alkene is:

(1)

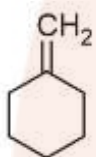

(2)

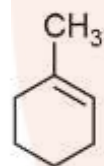

(3)

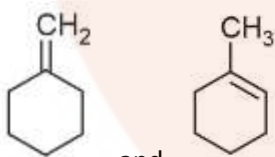

(4)

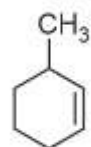

Solution: (3)

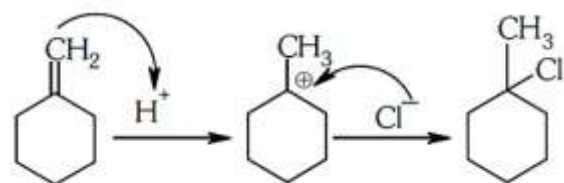

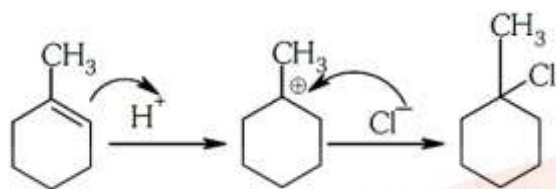

151. 2,3-Dimethyl-2-butene can be prepared by heating which of the following compounds with a strong acid?

- (1) $(\text{CH}_3)_3\text{C} - \text{CH} = \text{CH}_2$
- (2) $(\text{CH}_3)_2\text{C} = \text{CH} - \text{CH}_2 - \text{CH}_3$
- (3) $(\text{CH}_3)_2\text{CH} - \text{CH}_2 - \text{CH} = \text{CH}_2$
- (4) $(\text{CH}_3)_2\text{CH} - \underset{\text{CH}_3}{\text{CH}} - \text{CH} = \text{CH}_2$

Solution: (1)

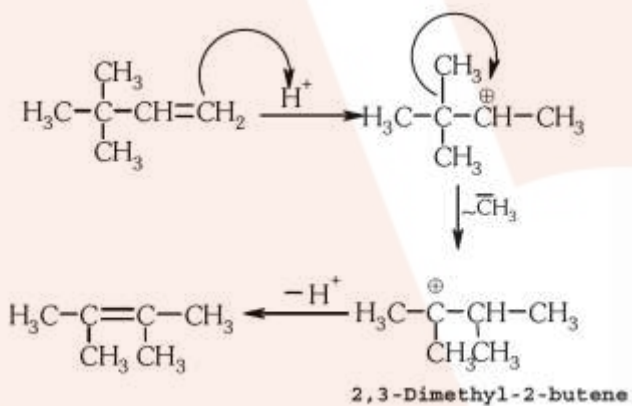

152. The hybridization involved in complex $[\text{Ni}(\text{CN})_4]^{2-}$ is: (Atomic number of Ni = 28)

- (1) sp^3
- (2) d^2sp^2
- (3) d^2sp^3
- (4) dsp^2

Solution: (4)



Oxidation state of Ni is +2

$$x - 4 = 2$$

$$x = +2$$

153. Reaction of a carbonyl compound with one of the following reagents involves nucleophilic addition followed by elimination of water. The reagent is:

- (1) Hydrazine in presence of feebly acidic solution
- (2) Hydrocyanic acid
- (3) Sodium hydrogen sulphite
- (4) A Grignard reagent

Solution: (1) With Ammonia derivation carbonyl compounds give addition followed by elimination reaction. Slightly acidic medium will generate a nucleophilic centre for weak base like ammonia derivatives.

154. Two possible stereo-structures of $\text{CH}_3\text{CHOH} \cdot \text{COOH}$, which are optically active, are called:

- (1) Atropisomers
- (2) Enantiomers
- (3) Mesomers
- (4) Diastereomers

Solution: (2)

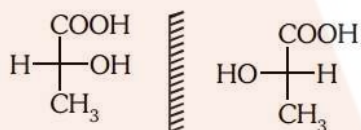

Both are enantiomers.

155. In the extraction of copper from its sulphide ore, the metal is finally obtained by the reduction of cuprous oxide with:

- (1) Carbon monoxide
- (2) Copper (I) sulphide
- (3) Sulphur dioxide
- (4) Iron (II) sulphide

Solution: (2)

Self-reduction

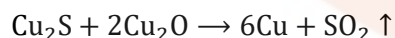

156. A gas such as carbon monoxide would be most likely to obey the ideal gas law at:

- (1) Low temperatures and high pressures
- (2) High temperatures and high pressures
- (3) Low temperatures and low pressures
- (4) High temperatures and low pressures

Solution: (4) Real gases show ideal gas behaviour at high temperatures and low pressures.

157. In an S_N1 reaction on chiral centres, there is:

- (1) Inversion more than retention leading to partial racemization
- (2) 100% retention
- (3) 100% inversion
- (4) 100% racemization

Solution: (1) S_N1 reaction gives racemic mixture with slight predominance of that isomer which corresponds to inversion because S_N1 also depends upon the degree of 'shielding' of the front side of the reacting carbon.

158. The vacant space in bcc lattice unit cell is:

- (1) 48%
- (2) 23%
- (3) 32%
- (4) 26%

Solution: (3) Packing efficiency in bcc lattice = 68%

$$\therefore \text{Vacant space in bcc lattice} = 100 - 68 = 32\%$$

159. The name of complex ion, $[\text{Fe}(\text{CN})_6]^{3-}$ is :

- (1) Hexacyanoferrate (III) ion
- (2) Tricyanoferrate (III) ion
- (3) Hexacyanidoferrate (III) ion
- (4) Hexacyanoiron (III) ion

Solution: (3)



Hexacyanidoferrate (III) ion

160. The number of water molecules is maximum in:

- (1) 1.8 gram of water
- (2) 18 gram of water
- (3) 18 moles of water
- (4) 18 molecules of water

Solution: (3)

$$\therefore 1 \text{ mole water} = 6.02 \times 10^{23} \text{ molecules}$$

$$\therefore 18 \text{ mole water} = 18 \times 6.02 \times 10^{23} \text{ molecules}$$

So, 18 mole water has maximum number of molecules.

161. The heat of combustion of carbon to CO_2 is -393.5 kJ/mol . The heat released upon formation of 35.2 g of CO_2 from carbon and oxygen gas is:

- (1) $+315 \text{ kJ}$
- (2) -630 kJ
- (3) -3.15 kJ
- (4) -315 kJ

Solution: (4) Formation of CO_2 from carbon and dioxygen gas can be represented as

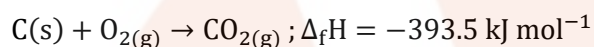

(1 mole = 44 g)

Heat released on formation of 44 g CO_2

$$= -393.5 \text{ kJ mol}^{-1}$$

$$= \frac{-393.5 \text{ kJ mol}^{-1}}{44 \text{ g}} \times 35.2 \text{ g}$$

$$= -315 \text{ kJ}$$

162. Aqueous solution of which of the following compounds is the best conductor of electric current?

- (1) Hydrochloric acid, HCl
- (2) Ammonia, NH_3
- (3) Fructose, $\text{C}_6\text{H}_{12}\text{O}_6$
- (4) Acetic acid, $\text{C}_2\text{H}_4\text{O}_2$

Solution: (1) Aqueous solution of HCl is the best conductor of electric current because HCl is strong acid, so it dissociates completely into ions.

163. In which of the following pairs, both the species are not isostructural?

- (1) Diamond, silicon carbide
- (2) NH_3 , PH_3
- (3) XeF_4 , XeO_4
- (4) SiCl_4 , PCl_4^+

Solution: (3)

- i. Hybridization of NH_3 [$\sigma = 3$, $\text{lp} = 1$]
 sp^3 geometry : Tetrahedral

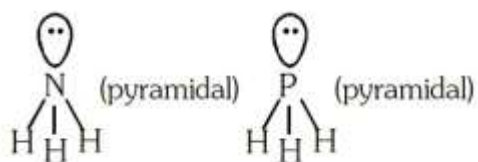

ii. Structures of XeF_4 is square planar.

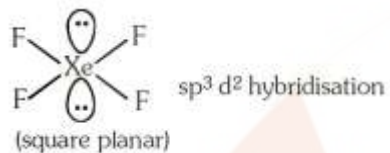

Structure of XeO_4 is tetrahedral

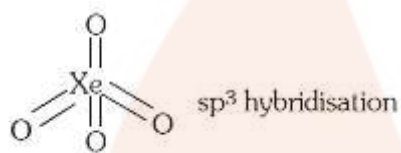

So XeF_4 and XeO_4 are not isostructural.

iii. Structure of SiCl_4 is tetrahedral.

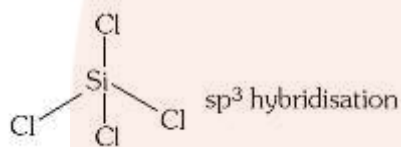

Structure of PCl_4^+ is tetrahedral.

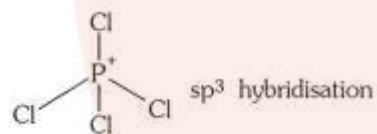

164. What is the mole fraction of the solute in a 1.00 m aqueous solution?

- (1) 1.770
- (2) 0.0354
- (3) 0.0177
- (4) 0.177

Solution: (3) 1.0 m solution means 1 mole solute is present in 1000 g water.

$$n_{\text{H}_2\text{O}} = 55.5 \text{ mol H}_2\text{O}$$

$$X_{\text{Solute}} = \frac{n_{\text{Solute}}}{n_{\text{Solute}} + n_{\text{H}_2\text{O}}} = \frac{1}{1 + 55.5} = 0.0177$$

165. Which of the following statements is not correct for a nucleophile?

- (1) Ammonia is a nucleophile
- (2) Nucleophiles attack low e^- density sites

- (3) Nucleophiles are not electron seeking
(4) Nucleophile is a Lewis acid

Solution: (4) Reason: Nucleophiles are electron rich species so act as Lewis base.

166. The sum of coordination number and oxidation number of metal M in the complex $[M(en)_2(C_2O_4)]Cl$ (Where en is ethylenediamine) is:

- (1) 6
(2) 7
(3) 8
(4) 9

Solution: (4)

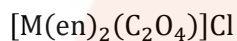

Oxidation state of M = +3

Coordination number of M = 6

Sum of oxidation state + Coordination number = 3 + 6 = 9

167. Assuming complete ionization, same moles of which of the following compounds will require the least amount of acidified $KMnO_4$ for complete oxidation?

- (1) $FeSO_3$
(2) FeC_2O_4
(3) $Fe(NO_2)_2$
(4) $FeSO_4$

Solution: (4) $MnO_4^- \rightarrow Mn^{2+}$; Change in oxidation no. = 5

In option,

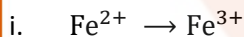

Change in oxidation no. = 1

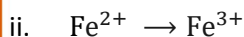

Change in oxidation no. = 1

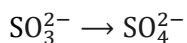

Change in oxidation no. = 2

$$= 1 + 2 = 3$$

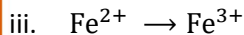

Change in oxidation no. = 1

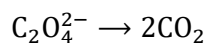

Change in oxidation no. = 2

$$= 1 + 2 = 3$$

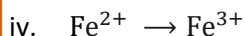

Change in oxidation no. = 1

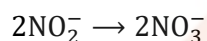

Change in oxidation no. = 4

$$= 1 + 4 = 5$$

168. Reaction of phenol with chloroform in presence of dilute sodium hydroxide finally introduces which one of the following functional group?

- (1) -COOH
- (2) -CHCl₂
- (3) -CHO
- (4) -CH₂Cl

Solution: (3) Reimer Tieman reaction

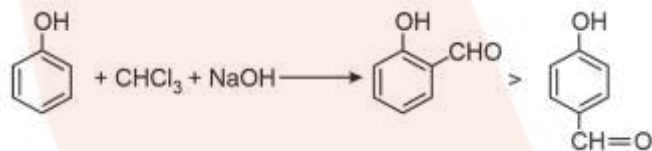

169. Which is the correct order of increasing energy of the listed orbitals in the atom of titanium?

(At. No. Z = 22)

- (1) 4s 3s 3p 3d
- (2) 3s 3p 3d 4s
- (3) 3s 3p 4s 3d
- (4) 3s 4s 3p 3d

Solution: (3) $\text{Ti}(22) = 1s^2 2s^2 2p^6 3s^2 3p^6 4s^2 3d^2$

Order of energy is 3s 3p 4s 3d

170. Which one of the following pairs of solution is not an acidic buffer?

- (1) CH_3COOH and CH_3COONa
- (2) H_2CO_3 and Na_2CO_3
- (3) H_3PO_4 and Na_3PO_4
- (4) HClO_4 and NaClO_4

Solution: (4) Strong acid with its salt cannot form buffer solution. HClO_4 and NaClO_4 cannot act as an acidic buffer.

171. Number of possible isomers for the complex $[\text{Co}(\text{en})_2\text{Cl}_2]\text{Cl}$ will be: (en = ethylene diamine)

- (1) 1
- (2) 3
- (3) 4
- (4) 2

Solution: (2) $[\text{Co}(\text{en})_2\text{Cl}_2]\text{Cl}$

Possible isomers

(i) Geometrical isomers

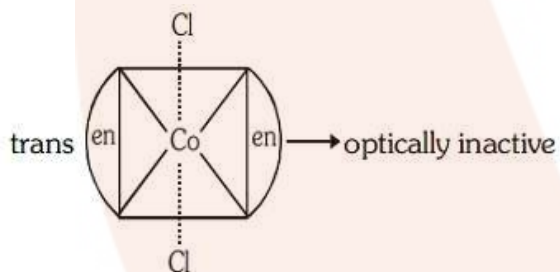
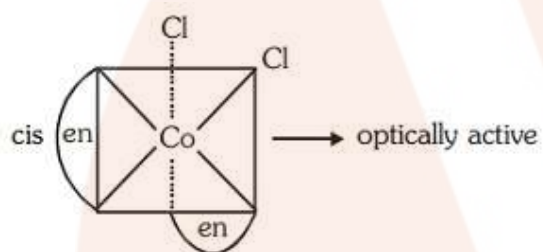

(ii) In trans form plane of symmetry present, so trans form is optically inactive but cis is optically active.

Total number of stereoisomer = 2 + 1 = 3

172. Decreasing order of stability of O_2 , O_2^- , O_2^+ and O_2^{2-} is:

- (1) $\text{O}_2^{2-} > \text{O}_2^- > \text{O}_2 > \text{O}_2^+$
- (2) $\text{O}_2 > \text{O}_2^+ > \text{O}_2^{2-} > \text{O}_2^-$
- (3) $\text{O}_2^- > \text{O}_2^{2-} > \text{O}_2^+ > \text{O}_2$
- (4) $\text{O}_2^+ > \text{O}_2 > \text{O}_2^- > \text{O}_2^{2-}$

Solution: (4)

Given species: O_2 , O_2^- , O_2^+ , O_2^{2-}

Total number of electrons

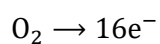

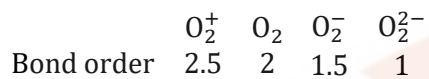
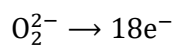
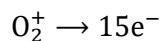
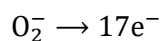

Stability \times Bond order

Stability order $[O_2^+ > O_2 > O_2^- > O_2^{2-}]$

173. Which of the following is not the product of dehydration of  ?

(1)

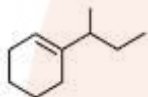

(2)

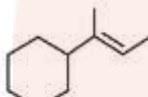

(3)

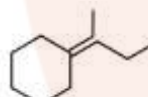

(4)

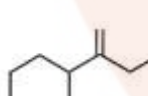

Solution: (1)

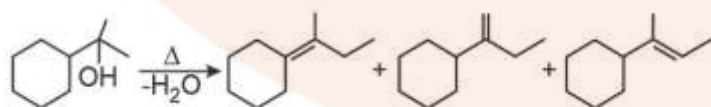

174. The correct statement regarding defects in crystalline solids is :

- (1) Frenkel defects decrease the density of crystalline solids
- (2) Frenkel defect is a dislocation defect
- (3) Frenkel defect is found in halides of alkaline metals
- (4) Schottky defects have no effect on the density of crystalline solids

Solution: (2) Frenkel defect is a dislocation defect.

175. The rate constant of the reaction $A \rightarrow B$ is 0.6×10^{-3} mole per second. If the concentration of A is 5M, then concentration of B after 20 minutes is:

- (1) 3.60 M
- (2) 0.36 M
- (3) 0.72 M
- (4) 1.08 M

Solution: (3)

For zero order reaction:

$$\begin{aligned}x &= K \cdot t \\ &= 0.6 \times 10^{-3} \times 20 \times 60 \\ x &= 0.72 \text{ M}\end{aligned}$$

176. On heating which of the following releases CO_2 most easily?

- (1) Na_2CO_3
- (2) MgCO_3
- (3) CaCO_3
- (4) K_2CO_3

Solution: (2)

Thermal stability order

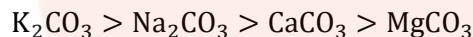

Therefore MgCO_3 releases CO_2 most easily.

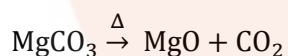

177. 20.0 g of a magnesium carbonate sample decomposes on heating to give carbon dioxide and 8.0 g magnesium oxide. What will be the percentage purity of magnesium carbonate in the sample?

(Atomic weight: Mg = 24)

- (1) 96
- (2) 60
- (3) 84
- (4) 75

Solution: (3)



$$\text{Moles of MgCO}_3 = \frac{20}{84} = 0.238 \text{ mol}$$

From above equation.

1 mole MgCO_3 gives 1 mole MgO

\therefore 0.238 mole MgCO_3 will give 0.238 mole MgO

$$= 0.238 \times 40 \text{ g} = 9.523 \text{ g MgO}$$

Practical yield of $\text{MgO} = 8 \text{ g MgO}$

$$\therefore \% \text{ Purity} = \frac{8}{9.523} \times 100 = 84\%$$

178. Which one of the following esters gets hydrolyzed most easily under alkaline conditions?

(1)

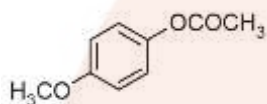

(2)

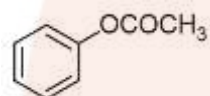

(3)

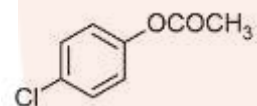

(4) D

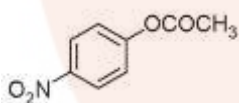

Solution: (4)

EWG (Electron withdrawing group) increases reactivity towards nucleophilic substitution reaction. $-\text{NO}_2$ is strong electron withdrawing group.

179. Caprolactum is used for the manufacture of:

- (1) Teflon
- (2) Terylene
- (3) Nylon-6,6
- (4) Nylon-6

Solution: (4)

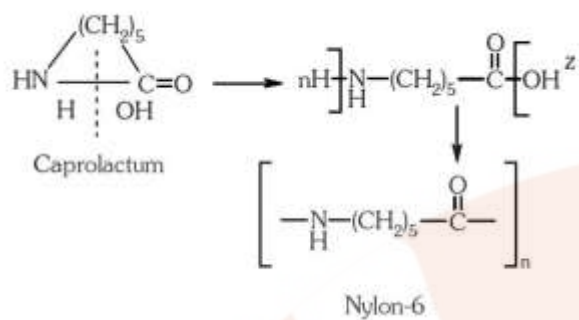

180. Which of the following reaction(s) can be used for the preparation of alkyl halides?

- I. $\text{CH}_3\text{CH}_2\text{OH} + \text{HCl} \xrightarrow{\text{Anhyd. ZnCl}_2}$
- II. $\text{CH}_3\text{CH}_2\text{OH} + \text{HCl} \rightarrow$
- III. $(\text{CH}_3)_3\text{COH} + \text{HCl} \rightarrow$
- IV. $(\text{CH}_3)_2\text{CHOH} + \text{HCl} \xrightarrow{\text{Anhyd. ZnCl}_2}$

- (1) I and II only
 (2) IV only
 (3) III and IV only
 (4) I, III and IV only

Solution: (4)

I and IV can be used due to presence of anhydrous ZnCl_2 (III) gives alkyl halide due to formation of more stable carbocation.